

**Enjoy peace of mind.  
Register your appliance today.**

Stay updated on better living services, safety notices and shop for accessories.

- 1. Open the camera app on your smartphone and point at the QR code to scan**  
Product Registration QR code is located on the front of your appliance or inside the door rim\*.

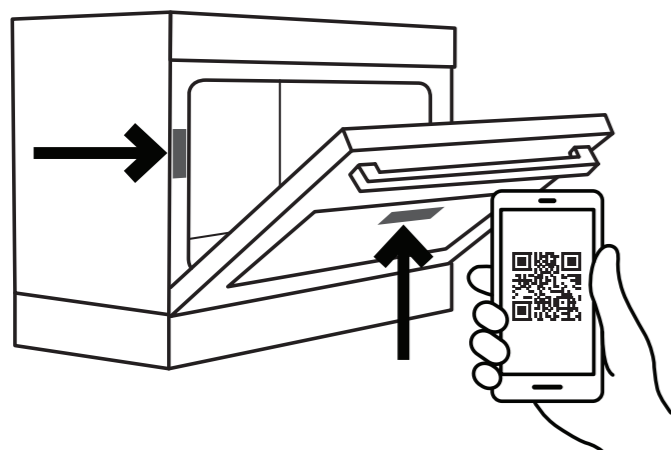

- 2. Tap the notification or link to open the registration form**
- 3. Complete your details and enjoy peace of mind**

\*Exact location of QR code may vary depending on oven model



**Need more help?**

To access your detailed user manual online, simply scan the QR code on your smart phone. If you prefer a printed manual, please contact our Customer Care Centre using details below.



**Contact us if you need more help**

**Electrolux Home Products Australia**

telephone: 13 13 49  
email: [customercare@electrolux.com.au](mailto:customercare@electrolux.com.au)  
web: [electrolux.com.au](http://electrolux.com.au)

**Electrolux Home Products New Zealand**

telephone: 0800 436 245  
email: [customercare@electrolux.co.nz](mailto:customercare@electrolux.co.nz)  
web: [electrolux.co.nz](http://electrolux.co.nz)

Dear Customer,

Thank you for purchasing a Westinghouse appliance. You have chosen a product that comes from a history of durable and reliable products loved by many families. We look to help you make the most of your time at home, so you can spend your time doing what you really love, with the ones you love.

Welcome to Westinghouse.

**Ready**



**This is a Quick Start Guide. Please refer to user manual online for detailed information and installation**

To access your detailed user manual online, simply scan the QR code on your smart phone.

For more detailed information and installation guide refer to user manuals at [westinghouse.com.au/manuals](http://westinghouse.com.au/manuals)

**Before you start, please make sure:**

- Your oven has been correctly installed by a qualified person.
- Your oven has power and is switched on.
- You've removed all relevant packaging.



Most of the packaging materials can be recycled. Please dispose of them at your local recycling centre or in your own recycling bin.

**Set...**

**Get to know your control panel:**

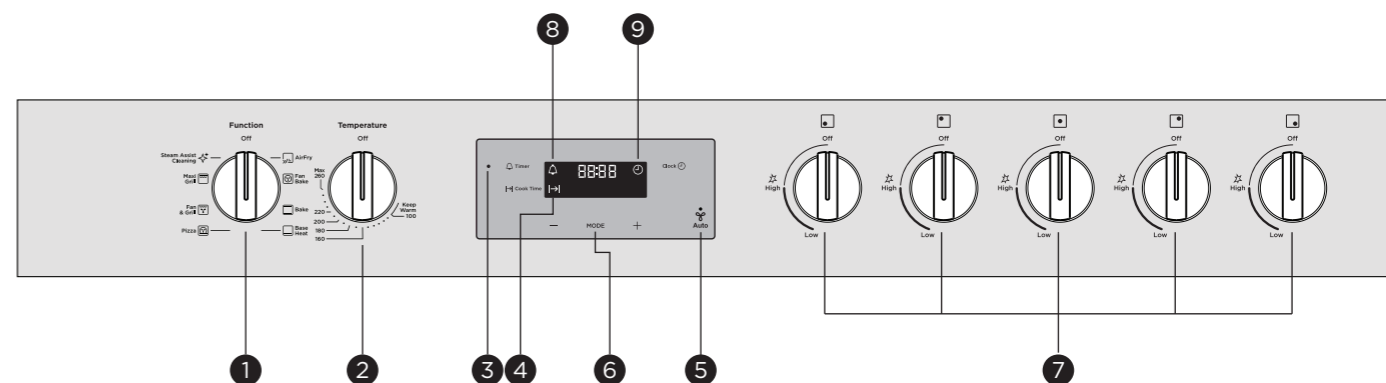

- |   |                                  |                                 |
|---|----------------------------------|---------------------------------|
| <b>1</b> Oven function selector         | <b>4</b> Cook time icon          | <b>8</b> Indicates timer is set |
| <b>2</b> Oven/grill temperature control | <b>5</b> Hob2Hood Control        | <b>9</b> Time of day icon       |
| <b>3</b> Function indicator light       | <b>6</b> Electronic clock        |                                 |
|   | <b>7</b> Gas hob burner controls |                                 |

# Set...

## Installing the accessories

**1. Install the telescopic slides (where supplied) to the side racks. Refer to the installation guide supplied with the telescopic slides.**

**2. Insert side racks.**

There is a left hand and right hand version (see image).

1. Insert the rear peg into the rear access hole, ensuring that the peg is fully inserted.
2. Then locate the front peg into the front access hole and push in firmly.

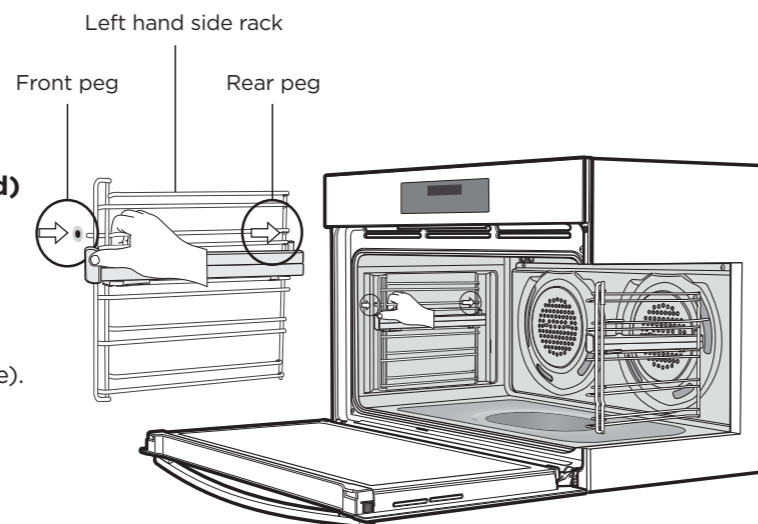

**3. To fit a shelf or tray to side racks:**

1. Locate the rear edge of the shelf in between guide rails of the side rack. Ensure the same rail positions on both sides of the oven are being engaged.
2. With the front edge raised, slide the shelf into the oven.
3. Once the detents have passed the front edge of the side rack, the shelf can be pushed completely in.

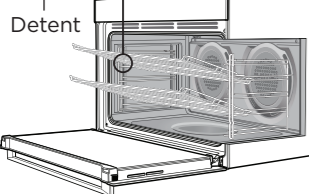
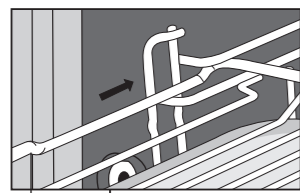

**4. Fit shelf/tray (where supplied) to telescopic slides**

1. Push the shelf or tray along the top of the slide until it hits the back post.

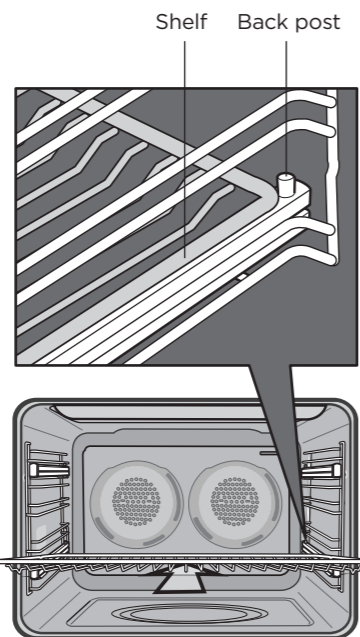

2. Drop the front of the shelf or tray onto the slide ensuring it sits behind the front post of the slide.

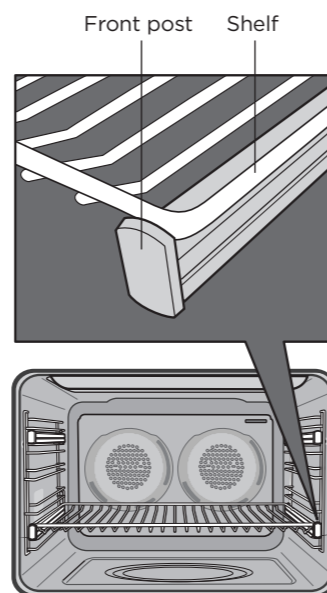

3. When fully inserted the shelf/tray should not interfere with the closed oven door.

## Set the time

You must set the time before you can operate the appliance.

1. After the appliance has been electrically connected, clock icon will flash.
2. Press + or - symbols to set the time of day.
3. 5 seconds after the last change, the clock icon will disappear, confirming the time has been adjusted.

*Note: The clock has a 24 hour display.*

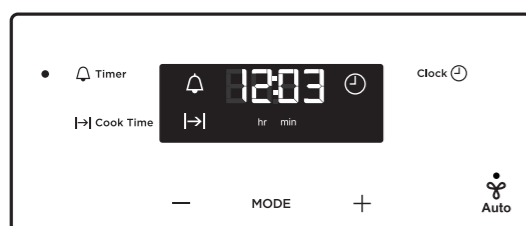

## Condition the oven (to burn off any residue)

New appliances can have oil or residue left from manufacturing. You will need to heat your oven for 2 hours before using it for the first time.

1. Turn the function selector dial to 'Fan Bake'.
2. Using the temperature control knob, set the oven at 180°C for approximately 2 hours. Please ensure that the room is well ventilated during this process.

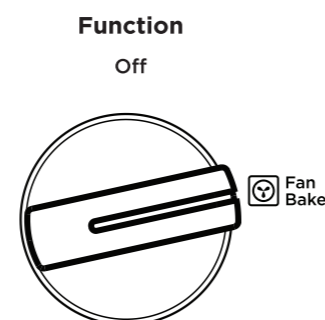

# Go!

**You're ready to use your new Westinghouse appliance. A few tips from us:**

**Remember to pre-heat each time.**

For best cooking results pre-heat the oven. Pre-heating allows the oven to reach the required temperature quickly and efficiently as well as cook food at the correct temperature for the entire cook time. Recommended pre-heat time is 30 minutes for baking and 3 minutes for grilling.

**Choose the right program for the best result:**

**GAS COOKTOP**



### Gas cooktop

Whether you're cooking a stir fry, searing a steak, grilling vegetables or boiling water, our intense burners provide high heat to help lock in the flavours or to speed things up.

To light a burner, firstly press the knob and turn it anti-clockwise to the 'High' flame position. Release the knob once the flame is established and turn it further anti-clockwise to reduce the flame height as desired.

**HOB2HOOD**



Hob2Hood is an advanced automatic function which connects the hob to a special hood. Both the hob and the hood have an infra-red signal communicator. The speed of the fan is defined automatically on the basis of the mode setting. You can operate the hood fan from the control panel using the HOB2HOOD button.

**FAN BAKE**



This setting is best used when cooking on multiple shelves at once or reheating complete meals for your family.

**STEAM ASSIST CLEANING**



A 30-minute light oven cleaning that's chemical free, odour free and fast. Just add water, turn on the steam cycle and wait until it softens and loosens oven grime, grab a cloth, some detergent and wipe.

Your oven is clean again.

**MAXI GRILL**



"Maxi Grill" allows you to take full advantage of the large grill dish area and will cook faster than normal "Grill". Grill with the oven door closed. For best results it is recommended to preheat your grill for 3 minutes. This will help seal in the natural juices of steak, chops etc. for a better flavour.

**AIRFRY**



AirFry for that perfect, healthy crunch. When a food craving hits, make healthier and delicious food right in your oven. Deliver all the flavour and none of the guilt. AirFry allows you to make healthier tasty meals for the entire family - right in your oven.

Refer to your full user manual for more details on oven functions.

**Set your temperature**

- To set the temperature, turn the temperature control knob in a clockwise direction to the desired setting.
- An indicator light in the display will turn on and oven will begin to heat.
- Once the food is cooked, turn the temperature control knob back in an anti-clockwise direction to the "off" position.

*Note: The desired cooking function must be selected before the oven will turn on.*