

**Enjoy peace of mind.  
Register your appliance today.**

Stay updated on better living services,  
safety notices and shop for accessories.

- 1. Open the camera app  
on your smartphone  
and point at the QR  
code to scan.**

Product Registration QR code  
is located on the top surface  
or underside of your appliance.

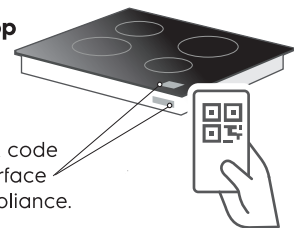

- 2. Tap the notification or link to open the  
registration form.**

- 3. Complete your details and enjoy peace  
of mind.**

## **INDUCTION COOKTOPS**

WHI632BE, WHI642BE, WHI942BE

## CONGRATULATIONS

Dear customer,

Congratulations on the purchase of your new cooktop.

Before you use the cooktop, we recommend that you read through the whole user manual which provides the description of the cooktop and its functions.

To avoid the risks that are always present when you use an electrical appliance, it is important that the cooktop is installed correctly and that you read the safety instructions carefully to avoid misuse and hazards.

We recommend that you keep this instruction booklet for future reference and pass it on to any future owners.

After unpacking the appliance, please check it is not damaged. If in doubt, do not use the appliance but contact your local Customer Care Centre.

For contact details, refer to the last page of this user manual. This appliance complies with requirements of Australian Standard AS/NZS 60335.1 and AS/NZS 60335.2.6

### Conditions of use

This appliance is intended to be used in household and similar applications such as:

- Staff kitchen areas in shops, offices and other working environments
- Farm houses
- By clients in hotels, motels and other residential type environments
- Bed and breakfast type environments

**Please ensure you read the instruction manual fully before you call for service, or a full service fee could be applicable.**

Record model and serial number here:

Model number:.....

Serial number:.....

PNC:.....

## CONTENTS

Important safety instructions.....	3
Installation instructions.....	5
Specifications.....	7
Product description.....	8
Operating instructions.....	11
Helpful hints and tips.....	17
Care and cleaning.....	19
Troubleshooting.....	20
Warranty.....	23

Please read the user manual carefully and store in a handy place for later reference.

The symbols you will see in this booklet have these meanings:



### WARNING

This symbol indicates information concerning your personal safety.



### CAUTION

This symbol indicates information on how to avoid damaging the appliance.



### IMPORTANT

This symbol indicates tips and information about use of the appliance.



### ENVIRONMENT

This symbol indicates tips and information about economical and ecological use of the appliance.

### IMPORTANT INFORMATION THAT MAY IMPACT YOUR MANUFACTURER'S WARRANTY

Adherence to the directions for use in this manual is extremely important for health and safety. Failure to strictly adhere to the requirements in this manual may result in personal injury, property damage and affect your ability to make a claim under the Westinghouse manufacturer's warranty provided with your product. Products must be used, installed and operated in accordance with this manual. You may not be able to claim on the Westinghouse manufacturer's warranty in the event that your product fault is due to failure to adhere this manual.

# IMPORTANT SAFETY INSTRUCTIONS



## IMPORTANT

Check for any damage or marks

If you find the cooktop is damaged or marked, you must report it within 7 days if you wish to claim for damage/marks under the manufacturer's warranty. This does not affect your statutory rights.



## ENVIRONMENT

Information on disposal for users

- All of the packaging materials are recyclable. Please dispose of those materials through your local recycling depot or by placing them in appropriate collection containers.
- If you wish to discard this product, please contact your local authorities and ask for the correct method of disposal.



## WARNING

Risk of suffocation, injury or permanent disability.

- Do not let persons, children included, with reduced physical sensory, reduced mental functions or lack of experience and knowledge use the appliance. They must have supervision or instruction for the operation of the appliance by a person who is responsible for their safety.
- Do not let children play with the appliance.
- Keep all packaging away from children.
- Keep children and pets away from the appliance when it operates or when it cools down. Accessible parts are hot.
- If the appliance has a child safety device, we recommend that you activate it.

## Installation



## WARNING

Only a qualified person must install this appliance.

- Remove all the packaging.
- Do not install or use a damaged appliance.
- Obey the installation instruction supplied with the appliance.
- Keep the minimum distance from the other appliances and units.
- Always be careful when you move the appliance because it is heavy. Always wear safety gloves.
- Seal the cut surfaces with a sealant to prevent moisture to cause swelling.
- Protect the bottom of the appliance from steam and moisture.
- Do not install the appliance adjacent to a door or under a window. This prevents hot cookware to fall from the appliance when the door or the window is opened.
- If the appliance is installed above drawers make sure that the space, between the bottom of the appliance and the upper drawer, is sufficient for air circulation.
- The bottom of the appliance can get hot. We recommend to install a non-combustible separation panel under the appliance to prevent access to the bottom.

# IMPORTANT SAFETY INSTRUCTIONS

## Electrical connection



### WARNING

Risk of fire and electrical shock.

- All electrical connections must be made by a qualified electrician. Before wiring make sure the mains terminal is not live.
- Make sure the appliance is installed correctly. Loose and incorrect plug and socket connections can make the terminal become too hot.
- The appliance must be installed correctly to ensure anti-shock protection.
- Cables from other electrical appliances must not touch the hot surface of the appliance.
- Other than the connection point in the terminal block, do not let the electrical supply cord touch the appliance or hot cookware. Ensure electrical supply cord is not tangled.
- Use a strain relief clamp on cable.
- Use the correct mains cable.
- Make sure there is no damage to the mains plug and to the mains cable. Contact the Service Centre or an electrician to change a damaged mains cable.
- The electrical installation must have an isolation device which lets you disconnect the appliance from the mains at all poles. Refer to AS/NZS 3000. The isolation device must have a contact opening width of minimum 3mm.
- Use only correct isolation devices: line protecting cut-outs, fuses (screw type fuses removed from the holder), earth leakage trips and contactors.

## Use



### WARNING

Risk of injury, burns or electric shock.

- Use this appliance in a household environment.
- Do not change the specification of this appliance.
- Do not use an external timer or a separate remote-control system to operate the appliance.
- Do not let the appliance stay unattended during operation.
- Do not operate the appliance with wet hands or when it has contact with water.
- Do not put cutlery or saucepan lids on the cooking zones. They can become hot.
- Set the cooking zone to "off" after each use. Do not rely on the pan detector.
- Do not use the appliance as a work surface or as a storage surface.
- If there is a crack on the surface, disconnect power

supply to prevent the electrical shock.

- Users with a pacemaker must keep a distance of minimum 30 cm from the induction cooking zones when the appliance is in operation.



### WARNING

Risk of fire or explosion.

- Fats and oil when heated can release flammable vapours. Keep flames or heated objects away from fats and oils when you cook with them.
- The vapours that very hot oil releases can cause spontaneous combustion.
- Used oil, that can contain food remnants, can cause fire at a lower temperature than oil used for the first time.
- Do not put flammable products or items that are wet with flammable products in, near or on the appliance.
- Do not try to extinguish a fire with water. Disconnect the appliance and cover the flame with a lid or a fire blanket.



### WARNING

Risk of damage to the appliance.

- Do not keep hot cookware on the control panel.
- Do not let cookware to boil dry.
- Be careful not to drop utensils or cookware on the glass, the glass surface can be damaged
- Do not activate the cooking zones with empty cookware or without cookware.
- Do not put aluminium foil on the appliance.
- Cookware made of cast iron, aluminium or with a damaged bottom can cause scratches on the glass ceramic. Always lift these objects up when you have to move them on the cooking surface.

## Care And Cleaning



### WARNING

Risk of damage to the appliance.

- Clean regularly the appliance to prevent the deterioration of the surface material.
- Do not use water spray and steam to clean the appliance.
- Clean the appliance with a moist soft cloth. Only use neutral detergents. Do not use abrasive products, abrasive cleaning pads, solvents or metal objects.

If the supply cord is damaged, it must be replaced by the manufacturer, its service agent or similarly qualified persons in order to avoid a hazard.

# INSTALLATION INSTRUCTIONS

## Built-in appliances

- Only use the built-in appliances after you assemble the appliance into correct built-in units and work surfaces that align to the standards.

## Connection cable

- Use the correct mains cable of type H05BB-F Tmax 90°C (or higher) for a single phase or two phase connection.
- Replace the damaged mains cable with special cable (type H05V2V2-5/H05VVf) minimum 3x1.5mm<sup>2</sup> with an all-pole 16A breaker for WHI632BE, and 3x2.5mm<sup>2</sup> with an all-pole 20A breaker for WHI642BE and WHI942BE. Speak to your local service center.
- The cable conditions must be in accordance with AS/NZS 3000 and the terminal screws tightened securely.
- The connecting cable is to be secured with the mains cable cleat and the covering closed by pressing firmly (lock into place).
- Before switching on for the first time, any protective foil or stickers must be removed from the glass ceramic surface.

## To attach the seal

- Clean the worktop in the area of the cut out section.
- Bond the seal stripe supplied on the lower edge of the appliance along the outer edge of the glass ceramic. Do not extend it. Let stay the cut ends in the middle of one side. When you cut it to length (add some mm), push the two ends together.

## Assembly

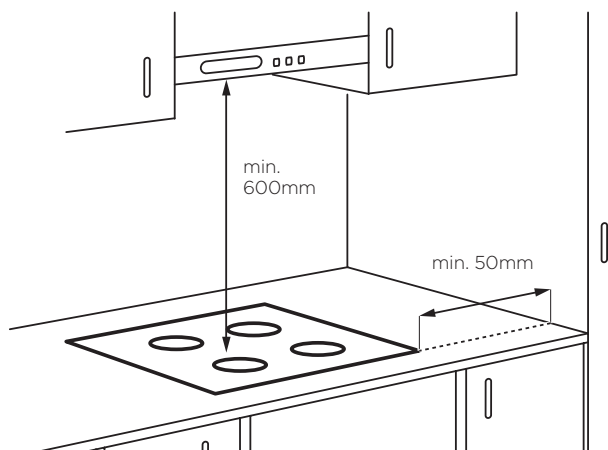

*NOTE: The clearance must meet or exceed the minimum recommended for both the rangehood and cooktop. Refer to the rangehood installation manual.*



## WARNING

Refer to "Safety information" chapter.



## IMPORTANT

Before the installation, note down the serial number (Ser. Nr.) from the rating plate at the front of this manual. The rating plate of the appliance is on its lower casing.

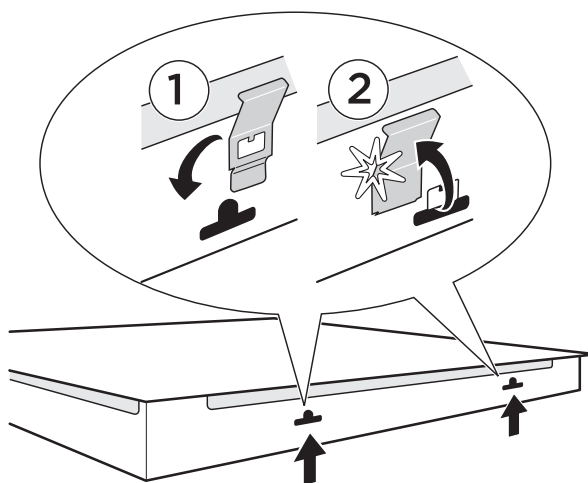
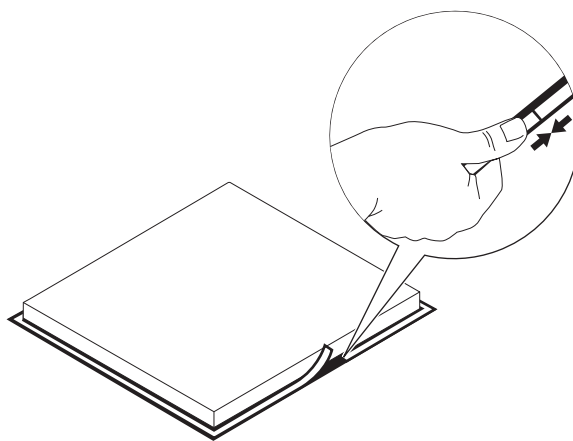

# INSTALLATION INSTRUCTIONS (CONTINUED)

## WHI642BE, WHI632BE

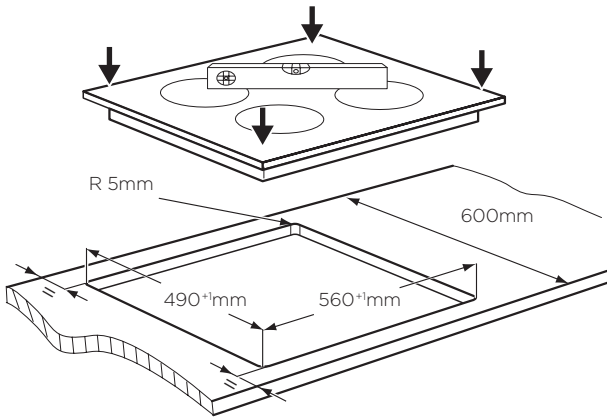

## WHI942BE

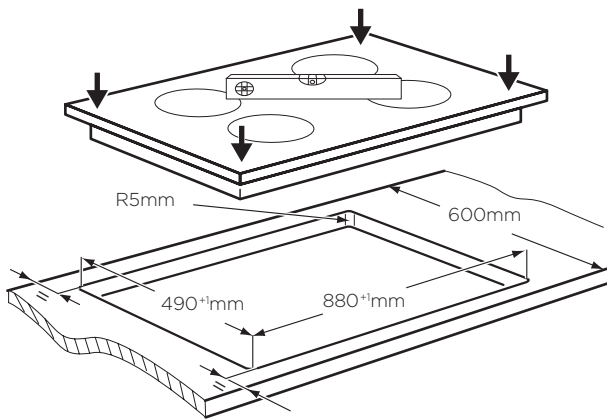

### **i** IMPORTANT

It is recommended to centre the bench cutout with equal distance front and back as shown but the product has also been certified to be installed with no clearance between the rear edge of the cooktop glass and rear wall if required. In doing so, installers still need to leave sufficient clearance to take into account that the glass dimensions are larger than the cut out.

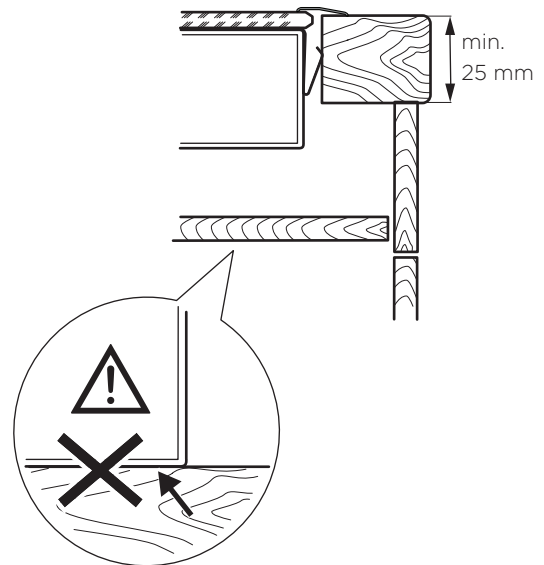
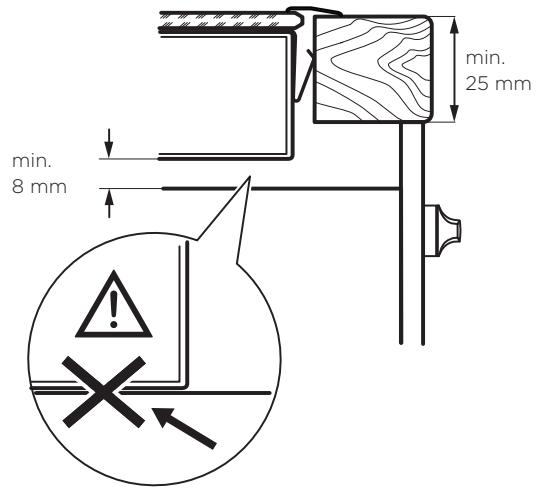

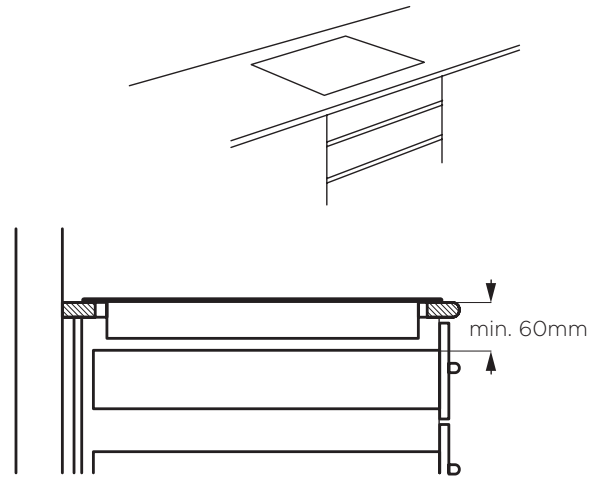
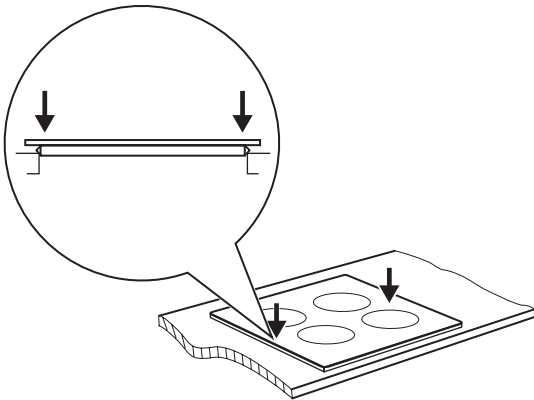

## SPECIFICATIONS

### Technical data

	WHI632BE	WHI642BE	WHI942BE
PNC	949163543	949163541	949163540
Product dimensions (w x d) mm	590 x 520	590 x 520	900 x 520
Cut-out dimensions (w x d) mm	560 x 490	560 x 490	880 x 490
Voltage (volts)	220-240	220-240	220-240
Frequency (Hz)	50	50	50
Total power (Watts)	3500	4600	4600
No. of cooking zones	3	4	4
Left front	1400/2500W(140mm)	2300/3200W(210mm)	2300/3200W(210mm)
Left rear	1800/2800W(180mm)	1400/2500W(140mm)	1400/2500W(140mm)
Right front	N/A	1400/2500W(140mm)	1400/2500W(140mm)
Right rear	N/A	1800/2800W(180mm)	1800/2800W(180mm)
Centre	N/A	N/A	N/A
Right	2300/3200W(240mm)	N/A	N/A



# PRODUCT DESCRIPTION

## WHI642BE

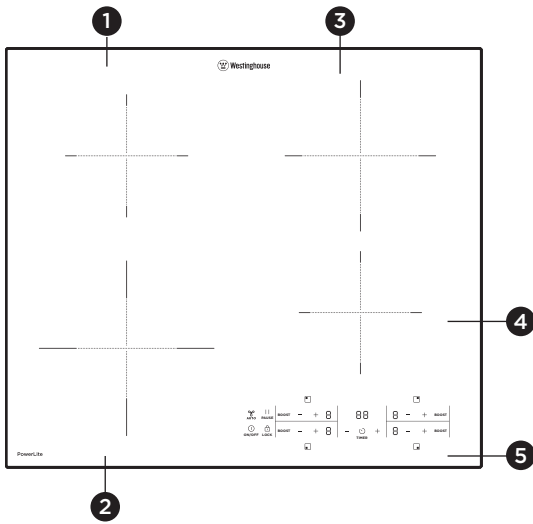

- 1 Induction cooking zone 1400 W, with Power function 2500 W (minimum cookware diameter =125 mm).
- 2 Induction cooking zone 2300 W, with Power function 3200 W (minimum cookware diameter =125 mm).
- 3 Induction cooking zone 1800 W, with Power function 2800 W (minimum cookware diameter =150 mm).
- 4 Induction cooking zone 1400 W, with Power function 2500 W (minimum cookware diameter =125 mm).
- 5 Control panel

## WHI632BE

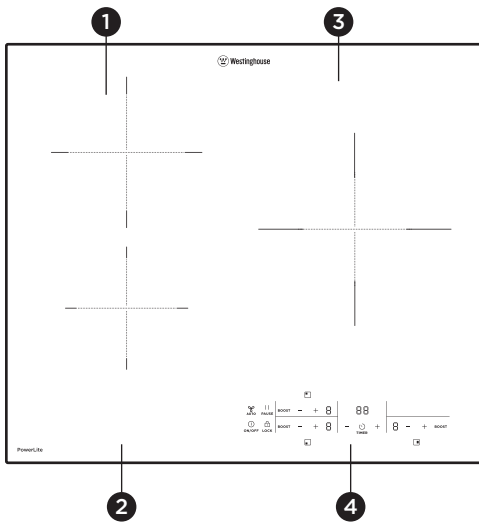

- 1 Induction cooking zone 1800 W, with Power function 2800 W (minimum cookware diameter =150 mm).
- 2 Induction cooking zone 1400 W, with Power function 2500 W (minimum cookware diameter =125 mm).
- 3 Induction cooking zone 2300 W, with Power function 3200 W (minimum cookware diameter =205 mm).
- 4 Control panel

## WHI942BE

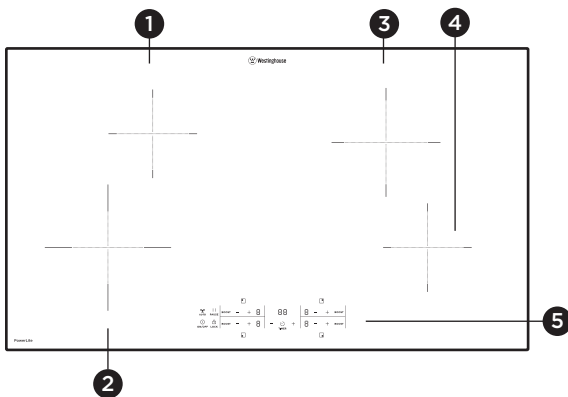

- 1 Induction cooking zone 1400 W, with Power function 2500 W (minimum cookware diameter =125 mm).
- 2 Induction cooking zone 2300 W, with Power function 3200 W (minimum cookware diameter =125 mm).
- 3 Induction cooking zone 1800 W, with Power function 2800 W (minimum cookware diameter =150 mm).
- 4 Induction cooking zone 1400 W, with Power function 2500 W (minimum cookware diameter =125 mm).
- 5 Control panel.



**Control panel layout - WHI642BE**

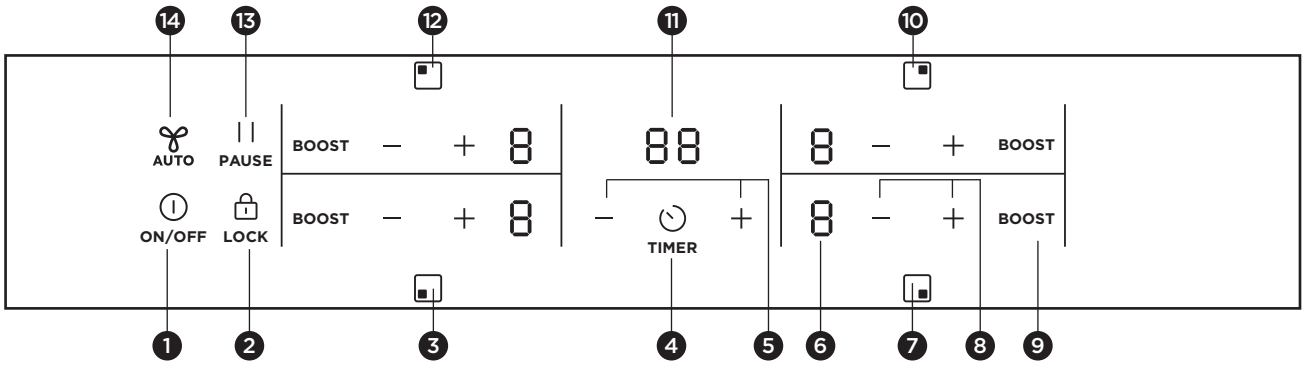

**Control panel layout - WHI632BE**

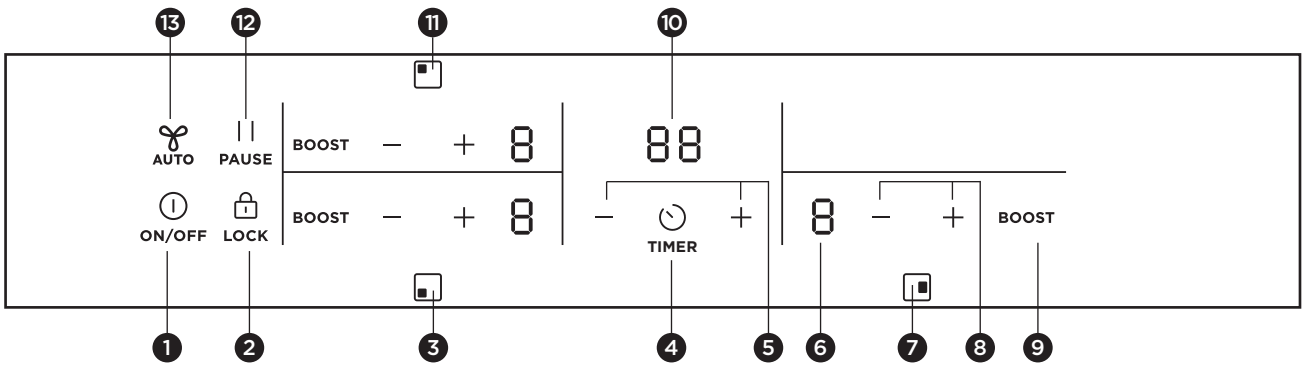



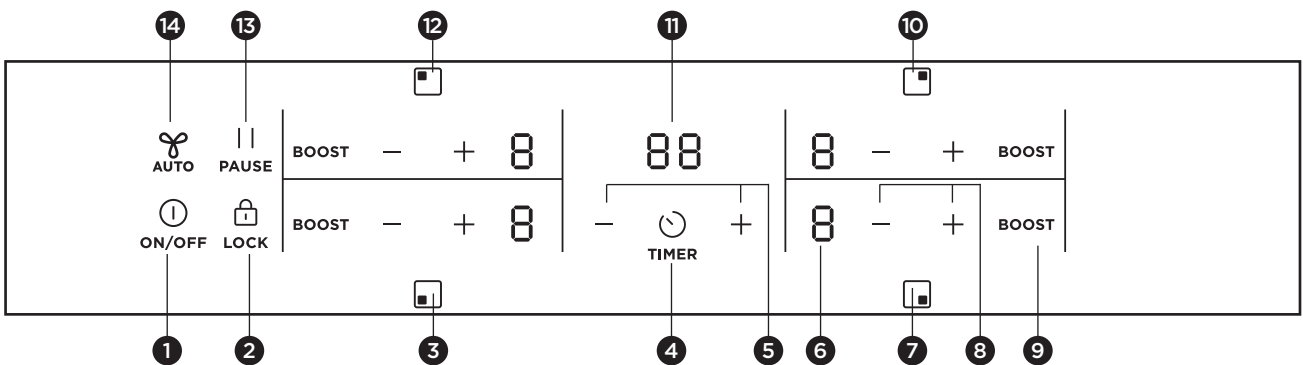





**Control panel layout - WHI942BE**













## PRODUCT DESCRIPTION (CONTINUED)

Use the sensor fields to operate the appliance. The displays, indicators and sounds tell which functions operate.

	SENSOR FIELD	FUNCTION
1	 ON/OFF	It activates and deactivates the appliance
2	 LOCK	It locks/unlocks the control panel
3		Left front (LF) cooking zone
4	 TIMER	To set the timer function
5	-/+	It increases or decreases the time
6	A heat setting display	It shows the heat setting
7		Right front (RF) cooking zone
8	-/+	It increases or decreases the heat setting
9	<b>BOOST</b>	It activates the PowerBoost function
10		Right rear (RR) cooking zone
11	The timer display	It shows the time in minutes
12		Left rear (LR) cooking zone
13	 <b>PAUSE</b>	Sets all operating zones to a keep warm setting
14	 <b>AUTO</b>	To activate and deactivate the manual mode of the Hob <sup>2</sup> Hood function

### Heat setting displays

DISPLAY	DESCRIPTION
	The cooking zone is deactivated.
	The Keep Warm function operates.
	The cooking zone operates.
	The Automatic Heat-up function operates.
	The cookware is incorrect or too small, or there is no cookware on the cooking zone.
 + digit	Fault code
	OptiHeat Control (3 step residual heat indicator): continue cooking / keep warm / residual heat
	The Lock/Child Safety device operates.
	The PowerBoost function operates.
	The Automatic Switch-Off operates.

# OPERATING INSTRUCTIONS

## Activation and deactivation

Touch **ON/OFF** for 1 second to activate or deactivate the appliance.

## Automatic switch off

The function deactivates the appliance automatically if:

- All cooking zones are deactivated (🔒).
- You do not set the heat setting after you activate the appliance.
- You spill something or put something on the control panel for more than 10 seconds, (a pan, a cloth, etc). The sound operates some time and the appliance deactivates. Remove the object or clean the control panel.
- The appliance become too hot (e.g. when a saucepan boils dry). Before you use the appliance again, the cooking zone must be cool.
- You use incorrect cookware. The symbol (🔒) comes on and the cooking zone deactivates automatically after 2 minutes.
- You do not deactivate a cooking zone or change the heat setting. After some time, (🔒) comes on and the appliance deactivates. See the Heat Setting display table below.

## The times of Automatic Switch Off

HEAT SETTING	COOKING ZONE DEACTIVATES AFTER
🔒 1 - 2	6 hours
3 - 4	5 hours
5	4 hours
6 - 9	1.5 hours

## The heat setting

Touch **+** or **-** repeatedly to select the desired heat setting. The display shows the heat setting (levels 1-9).

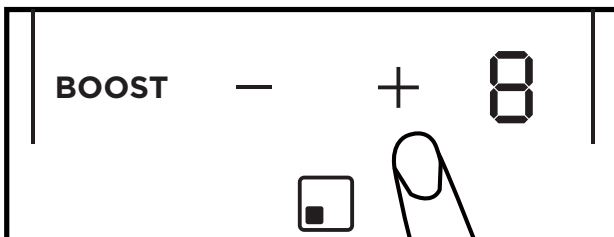

## Automatic heat up

You can get a necessary heat setting in a shorter time if you activate the Automatic Heat Up function. This function sets the highest heat setting for some time (see the illustration), and then decreases to the necessary heat setting.

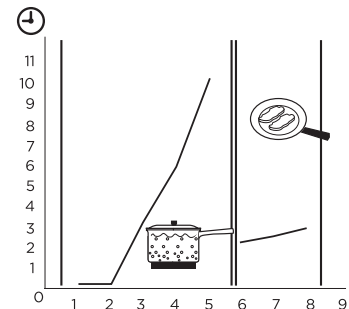

**i** To activate the function the cooking zone must be cold.

**To activate the function for a cooking zone:** Touch **BOOST** (🔒) comes on). Immediately touch **+** (🔒) comes on). Immediately touch **-** until the correct heat setting comes on. After 3 seconds (🔒) comes on.

**To deactivate the function:** Touch **-**.

## OptiHeat Control ( 3 step residual heat indicator)

**! WARNING**

🔒 / 🔒 / 🔒 Risk of burns from residual heat!

OptiHeat Control shows the level of the residual heat. The induction cooking zones make the heat necessary for cooking directly in the bottom of the cookware. The glass ceramic is hot from the heat of the cookware.

## PowerLite induction

The PowerLite induction hob provides a hassle-free way to transition from your current electric hob to induction hob, without having to upgrade your existing wiring, if your current wiring can support either 15amp (3.5kW) or 20amp (4.6kW).\*\*

When using more than one zone at the same time, the power sharing feature will activate to reduce the overall load. This may restrict the maximum heat level achievable for each zone.

It may be necessary to lower the settings on other zones before increasing the heat setting or activating an additional cooking zone.

The last assigned zone setting will be retained, and the other settings will be overridden. These settings will flash on the control panel display and will be automatically adjusted to the highest possible heat level within the power limit.

Model number:

WHI642BE 20amp (4.6kw)

WHI632BE 15amp (3.5kw)

WHI942BE 20amp (4.6kw)

\*\* Please consult a qualified electrician.

# WHI642BE

## 20AMP (4.6KW)

When using more than one zone at the same time, the power sharing feature will activate to reduce the overall load. This may restrict the maximum heat level achievable for each zone.

It may be necessary to lower the settings on other zones before increasing the heat setting or activating an additional cooking zone.

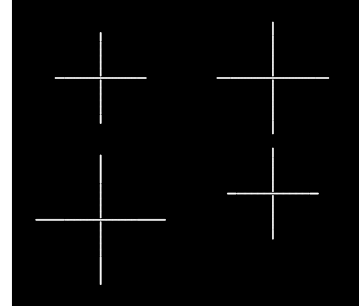

The last assigned zone's heat setting will be retained. The other settings may be adjusted if necessary, to the highest possible heat level within the power limit.

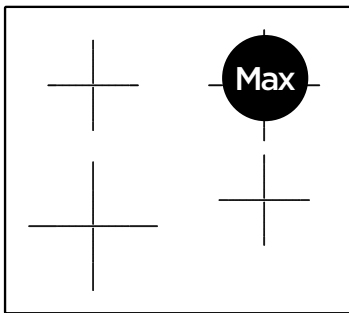

One zone in use

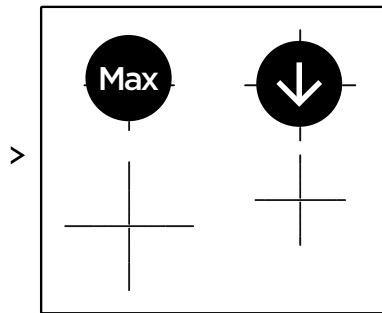

Two zones in use

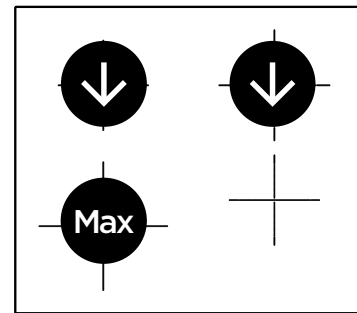

Three zones in use

The setting(s) being adjusted will toggle on the control panel, between the original heat level and the new heat level for approximately one minute, before stabilising at the new heat level.

Here are some examples of maximum heat setting combinations when using multiple cooking zones at the same time.

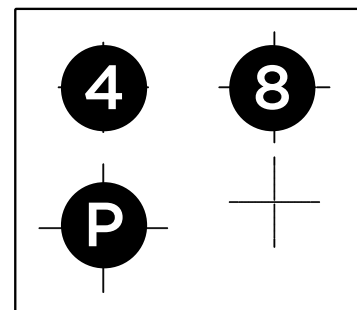
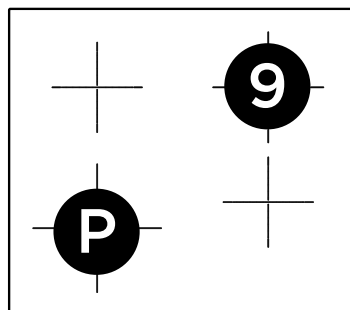

**Note:** PowerBoost is available on any zone when only one zone is activated.

# WHI632BE

## 15AMP (3.5KW)

When using more than one zone at the same time, the power sharing feature will activate to reduce the overall load. This may restrict the maximum heat level achievable for each zone.

It may be necessary to lower the settings on other zones before increasing the heat setting or activating an additional cooking zone.

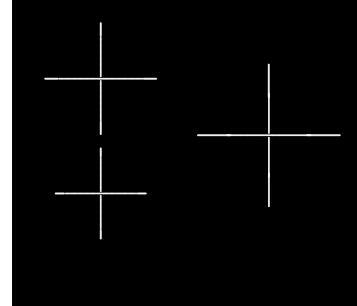

The last assigned zone's heat setting will be retained. The other settings may be adjusted if necessary, to the highest possible heat level within the power limit.

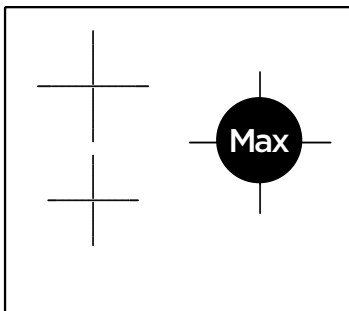

One zone in use

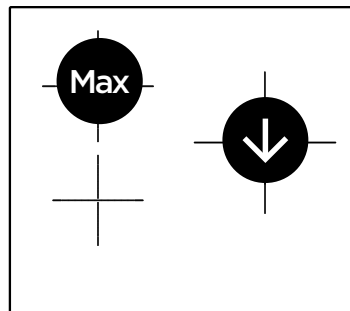

Two zones in use

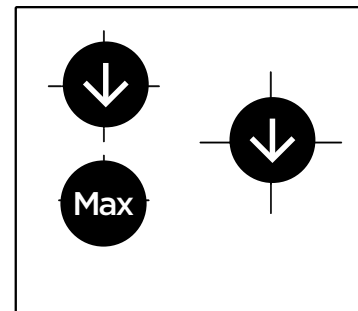

Three zones in use

The setting(s) being adjusted will toggle on the control panel, between the original heat level and the new heat level for approximately one minute, before stabilising at the new heat level.

Here are some examples of maximum heat setting combinations when using multiple cooking zones at the same time.

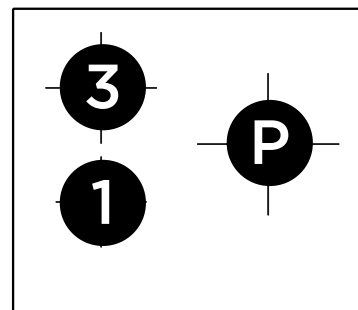
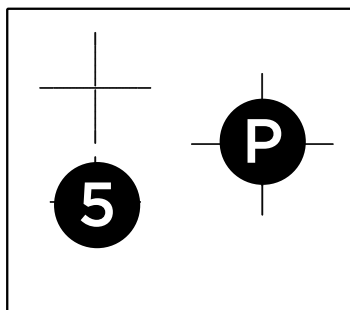

**Note:** PowerBoost is available on any zone when only one zone is activated.

# WHI942BE

## 20AMP (4.6KW)

When using more than one zone at the same time, the power sharing feature will activate to reduce the overall load. This may restrict the maximum heat level achievable for each zone.

It may be necessary to lower the settings on other zones before increasing the heat setting or activating an additional cooking zone.

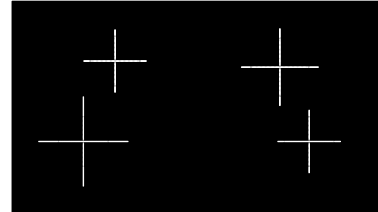

The last assigned zone's heat setting will be retained. The other settings may be adjusted if necessary, to the highest possible heat level within the power limit.

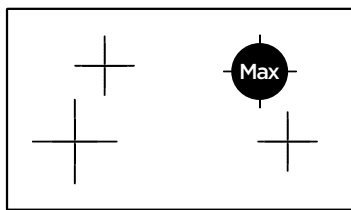

**One zone in use**

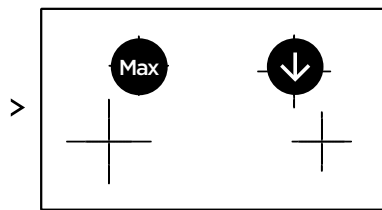

**Two zones in use**

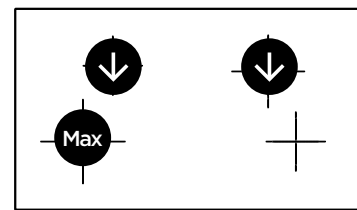

**Three zones in use**

The setting(s) being adjusted will toggle on the control panel, between the original heat level and the new heat level for approximately one minute, before stabilising at the new heat level.



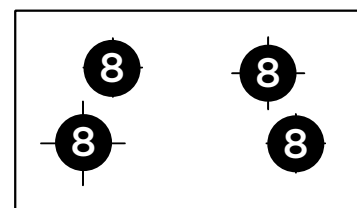
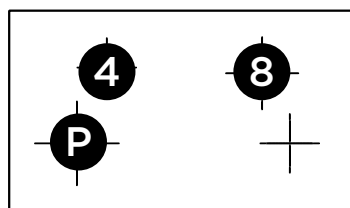









Here are some examples of maximum heat setting combinations when using multiple cooking zones at the same time.







**Note:** PowerBoost is available on any zone when only one zone is activated.

## Count down timer

Use the Count Down Timer to set how long the cooking zone operates for only this one time. **Set the Timer after the selection of the cooking zone.** You can set the heat setting before or after you set the timer.

- To set the cooking zone: Touch  repeatedly until the indicator of the required cooking zone lights up.
- Starting the Count Down Timer: Touch  of the timer to set the time (00 - 99 minutes). When the indicator of the cooking zone flashes slower, the time counts down.
- Checking the remaining time: Select the cooking zone with . The indicator of the cooking zone flashes faster. Display shows the remaining time.
- Changing the Count Down Timer: Select the cooking zone with , then touch  or .
- Stopping the timer: Select the cooking zone with , then touch . The remaining time counts backwards to 00. The indicator of the cooking zone goes out. To switch off you can also touch  or  at the same time.
- When the time elapses, the sound operates and  flashes. The cooking zone switches off.
- Stopping the sound: Touch .

## Minute minder



You can use the timer as a Minute Minder while cooking zones are not operating. Touch , then touch  or  of the timer to select the time. When the time elapses, the sound operates and  flashes.

## Pause (models with independent pause button)

The  function sets all cooking zones that are operating to the lowest heat setting .



When  operates, you cannot change the heat setting.

The  function does not stop the timer function.

- To activate this function touch . The  symbol comes on.
- To deactivate this function touch . The heat setting that you set before comes on.

## Locking the control panel

When the cooking zones operate, you can lock the control panel, but not **ON/OFF**. It prevents an accidental change of the heat setting.

First set the heat setting. To start this function touch . The symbol  comes on for 4 seconds. The Timer stays on.



To stop this function, touch . The heat setting that you set before comes on. When you stop the appliance, you

also stop this function.



## The child safety device

This function prevents an accidental operation of the appliance.



### To activate the child safety device

- Activate the appliance with **ON/OFF**. Do not set the heat settings.
- Touch  for 4 seconds. The symbol  comes on.
- Deactivate the appliance with **ON/OFF**.

### To deactivate the child safety device

- Activate the appliance with **ON/OFF**. Do not set the heat settings. Touch  for 4 seconds. The symbol  comes on.
- Deactivate the appliance with **ON/OFF**.

### To override the child safety device for only one time

- Activate the appliance with **ON/OFF**.
- Touch  for 4 seconds. The symbol  comes on. Set the heat setting in 10 seconds. You can operate the appliance.
- When you deactivate the appliance with **ON/OFF**, the child safety device operates again.

## Hob<sup>2</sup>Hood

This is an advanced automatic function which connects the hob to a special hood. Both the hob and the hood have an infra-red signal communicator. Speed of the fan is defined automatically on basis of mode setting and temperature of the hottest cookware on the hob. You can also operate the fan from the hob manually.

### IMPORTANT

For most of the hoods the remote system is originally deactivated. Activate it before you use the function. For more information refer to hood user manual.

### Operating the function automatically

The default automatic mode from the factory is H5. You can change the automatic mode by following the instructions below. When you activate the hob the hood will adjust the fan speed automatically. Please note the below table is a guide, the fan speed varies depending on the temperature measured on the cooking zones of the cooktop which can be affected by the heat setting(s) selected as well as the size and volume of what you are cooking.



## OPERATING INSTRUCTIONS (CONTINUED)

### Automatic modes

	AUTOMATIC LIGHT	BOILING <sup>1)</sup>	FRYING <sup>2)</sup>
Mode H0	Off	Off	Off
Mode H1	On	Off	Off
Mode H2 <sup>3)</sup>	On	Fan speed 1	Fan speed 1
Mode H3	On	Off	Fan speed 1
Mode H4	On	Fan speed 1	Fan speed 1
Mode H5	On	Fan speed 1	Fan speed 2
Mode H6	On	Fan speed 2	Fan speed 3

- 1). The hob detects the boiling process and activates fan speed in accordance with automatic mode.
- 2). The hob detects the frying process and activates fan speed in accordance with automatic mode.
- 3). This mode activates the fan and the light and does not rely on the temperature.

#### Changing the automatic mode

1. Deactivate the appliance.
2. Touch **ON/OFF** for 3 seconds. The display comes on and goes off.
3. Touch **LOCK** for 3 seconds.
4. Touch **TIMER** a few times until **H** comes on.
5. Touch **+** of the Timer to select an automatic mode.

### **i** IMPORTANT

To operate the hood directly on the hood panel, deactivate the automatic mode of the function.

### **i** IMPORTANT

When you finish cooking and deactivate the hob, the hood fan may still operate for a certain period of time. After that time the system deactivates the fan automatically and prevents you from accidental activation of the fan for the next 30 seconds.

### Operating the fan speed manually

You can also operate the function manually. To do that touch **AUTO** when the hob is active. This deactivates

automatic operation of the function and allows you to change the fan speed manually. When you press **AUTO** you raise the fan speed by one. When you reach an intensive level and press **AUTO** again you will set fan speed to 0 which deactivates the hood fan. To start the fan again with fan speed 1, touch **AUTO**.

### **i** IMPORTANT

To activate automatic operation of the function, deactivate the hob and activate it again.

### Activating the light

You can set the hob to activate the light automatically whenever you activate the hob. To do so set the automatic mode to H1 – H6.

### **i** IMPORTANT

The light on the hood deactivates 2 minutes after deactivating the hob.

### Hints and Tips for Hob<sup>2</sup>Hood function

When you operate the hob with Hob<sup>2</sup>Hood function:

- Protect the hood panel from direct sunlight.
- Do not spot halogen light on the hood panel.
- Do not cover the panel.
- Do not interrupt signal between the hob and the hood (for example with a hand or a cookware handle).

(Hood in the picture is only an example).

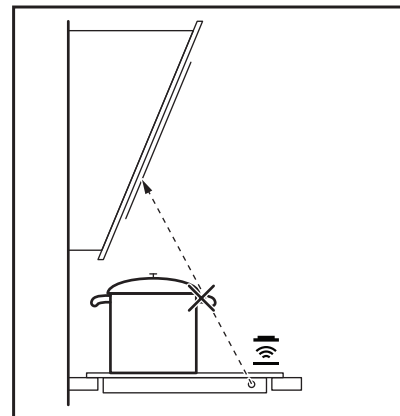

## HELPFUL HINTS AND TIPS



### IMPORTANT

Use the induction cooking zones with correct cookware.

#### Cookware for induction cooking zones



### IMPORTANT

For induction cooking zones a strong electromagnetic field creates the heat in the cookware very quickly.

#### Cookware material

- **Correct:** cast iron, steel, enamelled steel, stainless steel, the bottom made of multi-layer (with correct mark from a manufacturer).
- **Not correct:** aluminium, copper, brass, glass, ceramic or porcelain.

#### FIND THE RIGHT COOKWARE

Only magnetic pots and pans work with induction.

Check to see if your cookware is compatible: Place a magnet on the bottom of your pot or pan - if it clings firmly, the cookware will work with your cooktop.

Choose the right size pot or pan for the right cooking zone.



#### **MAGNET STICKS**

Cookware base material has good magnetic characteristics



#### **MAGNET FALLS**

Cookware base material is non-magnetic

#### Cookware is correct for an induction hob if ...

- Some water boils very quickly on a zone set to the highest heat setting.
- A magnet pulls on to the bottom of the cookware.



### IMPORTANT

The bottom of the cookware must be as thick and flat as possible. Cookware dimensions: induction cooking zones adapt to the dimension of the bottom of the cookware automatically to some limit.

#### Energy saving



### ENVIRONMENT

- If it is possible, always put the lids on the cookware.
- Put cookware on a cooking zone before you start it.



### IMPORTANT

It may happen that other remote controlled appliances may block the signal. To avoid it do not operate the remote of the appliance and the hob at the same time.

#### Rangehoods with the Hob<sup>2</sup>Hood function

To find the full range of rangehoods which work with this function refer to our consumer website. The Westinghouse rangehoods that work with this function

must have the symbol  **AUTO**.

## HELPFUL HINTS AND TIPS (CONTINUED)

### Examples of cooking applications

The relation between the heat setting and the cooking zone consumption of power is not linear. When you increase the heat setting it is not proportional to the increase of the cooking zone consumption of power.

It means that the cooking zone with the medium heat setting uses less than half the power of the high setting.



### IMPORTANT

The data in the table is for guidance only.

HEAT SETTING	USE TO:	TIME	HINTS
1	Keep food warm	as required	Put a lid on a cookware
1-2	Hollandaise sauce, melt: butter, chocolate, gelatine	5-25 min	Mix from time to time
1-2	Solidify: fluffy omelettes, baked eggs	10-40 min	Cook with a lid on
2-3	Simmer rice and milk based dishes, heating up ready-cooked meals	25-50 min	Add the minimum twice as much liquid as rice, mix milk dishes part procedure through
3-4	Steam vegetables, fish, meat	20-45 min	Add some tablespoons of liquid
4-5	Steam potatoes	20-60 min	Use max. 1/4 L water for 750g of potatoes
4-5	Cook larger quantities of food, stews and soups	60-150 min	Up to 3 L liquid plus ingredients
6-7	Gentle fry: escalope, veal cordon bleu, cutlets, rissoles, sausages, liver, roux, eggs, pancakes, doughnuts	as required	Turn halfway through
7-8	Heavy fry, hash browns, loin steaks, steaks	5-15 min	Turn halfway through
9	Boil large quantities of water, cook pasta, sear meat (goulash, pot roast), deep-fry chips		

The PowerBoost function is best to heat up large quantities of water.

# CARE AND CLEANING

## Care and cleaning

Clean the appliance after each use. Always use cookware with clean bottom.

### **i** IMPORTANT

Scratches or dark stains on the glass ceramic have no effect on how the appliance operates.

#### To remove the dirt:

1. **Remove immediately:** melted plastic, plastic foil, and food with sugar. If not, the dirt can cause damage to the appliance. Use a special scraper for the glass. Put the scraper on the glass surface at an acute angle and move the blade on the surface.

**Remove after the appliance is sufficiently cool:** limescale rings, water rings, fat stains, shiny metallic discolorations. Use a special cleaning agent for glass ceramic or stainless steel.

2. Clean the appliance with a moist cloth and some detergent.
3. At the end **rub the appliance dry with a clean cloth.**



If the deposit is minimal, simply wipe off with a dry cloth.



If the deposit is more important, clean off with a moist, soapy sponge and rinse off.



If the deposit does not clean off easily, use a non-abrasive scratch pad and a specially adapted glass-ceramic cleaning product

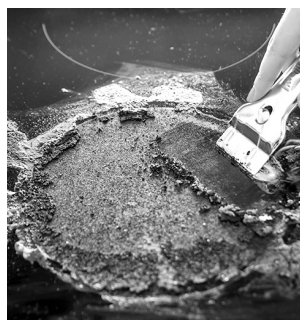

If the deposit does not clean off with any of the above mentioned methods, use a razor blade scraper, specially designed for glass-ceramic cooktops.



Having successfully cleaned the cooktop, apply a glass ceramic cooktop conditioner which will protect the cooktop surface against any future stains, with a dry cloth or equivalent.

## TROUBLESHOOTING

PROBLEM	POSSIBLE CAUSE	REMEDY
You cannot activate or operate the hob.	The hob is not connected to an electrical supply or it is connected incorrectly.	Check if the hob is correctly connected to the electrical supply. Refer to the connection diagram.
	The fuse is blown.	Make sure that the fuse is the cause of the malfunction. If the fuse is blown again and again, contact a qualified electrician.
	You do not set the heat setting for 10 seconds.	Activate the hob again and set the heat setting in less than 10 seconds.
	You touched 2 or more sensor fields at the same time.	Touch only one sensor field.
	There is water or fat stains on the control panel.	Clean the control panel.
An acoustic signal sounds and the hob deactivates. An acoustic signal sounds when the hob is deactivated.	You put something on one or more sensor fields.	Remove the object from the sensor fields.
The hob deactivates.	You put something on the sensor field.	Remove the object from the sensor field.
Residual heat indicator does not come on.	The zone is not hot because it has been operated only for a short time or the sensor is damaged.	If the zone has been operated sufficiently long to be hot, speak to an Authorised Service Centre.
Hob <sup>2</sup> Hood does not work.	You covered the control panel.	Remove the object from the control panel.
	You use a very tall pot which blocks the signal.	Use a smaller pot, change the cooking zone or operate the hood manually.
Automatic Heat Up does not operate.	The zone is hot.	Let the zone become sufficiently cool.
	The highest heat setting is set.	The highest heat setting has the same power as the function.
The heat setting changes between two levels.	Power management operates.	Refer to "Operating instructions".
The sensor fields become hot.	The cookware is too large or you put it too near to the controls.	Put large cookware on the rear zones, if possible.
There is no sound when you touch the panel sensor fields.	The sounds are deactivated.	Activate the sounds. Refer to "Operating instructions".
 comes on.	Child Safety Device or Lock operates.	Refer to "Operating instructions".

PROBLEM	POSSIBLE CAUSE	REMEDY
<b>F</b> comes on.	There is no cookware on the zone.	Put cookware on the zone.
	The cookware is unsuitable.	Use suitable cookware. Refer to "Hints and tips".
	The diameter of the bottom of the cookware is too small for the zone.	Use cookware with correct dimensions. Refer to "Technical data".
<b>F</b> and <b>I</b> appear alternately	The power is too low due to unsuitable cookware or an empty pot.	"Use the appropriate type of cookware. Refer to "Hints and Tips" and "Technical Data". Do not activate any zone with an empty pot on it."
<b>F</b> and <b>?</b> appear alternately	The pot is empty or contains some liquid other than water, e.g. oil.	Avoid using the function with liquids other than water.
<b>E</b> and a number come on.	There is an error in the hob.	Deactivate the hob and activate it again after 30 seconds. If <b>E</b> comes on again, disconnect the hob from the electrical supply. After 30 seconds, connect the hob again. If the problem continues, speak to an Authorised Service Centre.
You can hear a constant beep noise.	The electrical connection is incorrect.	Disconnect the hob from the electrical supply. Ask a qualified electrician to check the installation.

### If you cannot find a solution...

If you cannot find a solution to the problem yourself, contact your dealer or an Authorised Service Centre. Give the data from the rating plate. Give also three digit letter code for the glass ceramic (it is in the corner of the glass surface) and an error message that comes on.

Make sure, you operated the hob correctly. If not the servicing by a service technician or dealer will not be free of charge, also during the warranty period. The instructions about the Service Centre and conditions of guarantee are in the guarantee booklet.

### The noises during operation

If you can hear

- **crack noise:** cookware is made of different materials (Sandwich construction).
- **whistle sound:** you use one or more cooking zones with high power levels and the cookware is made of different materials (Sandwich construction).
- **humming:** you use high power levels.
- **clicking:** electric switching occurs.
- **hissing, buzzing:** the fan operates.

### The noises are normal and do not refer to appliance malfunction.

If unfamiliar with induction units, please first compare the operating sounds of a demonstration model at your retailer before calling service. If a service call is placed and the sounds are normal, you will be charged for the visit.

## TROUBLESHOOTING (CONTINUED)

### FAQs

#### **Display is flashing**

This is normal during power sharing mode. The power for the zone is automatically reduced to ensure the maximum power available is not exceeded.

#### **The display is switching between 2 power settings**

The heat setting display of the reduced zones changes between the initially selected heat setting and the reduced heat setting, it will stop switching after about 1 minute. The cooking zones will continue operating with the reduced heat setting. Change the heat setting of the cooking zones manually, if necessary.

#### **Power level for zone reduces when activating another zone**

This is normal during power sharing mode. The power for the zone is automatically reduced to ensure the maximum power available is not exceeded.

#### **The power level is showing '0'**

Power is not available to this zone. This may be due to other zones had maximised the power limit.

#### **PowerBoost switches off while cooking**

PowerBoost will last for 10 minutes for all zones, except for the smallest zone (Ø140mm) which will last for 4 minutes. It will automatically switch to level 9 afterwards.

#### **Cannot activate PowerBoost in 2 or more zones**

PowerBoost can only be activated for one zone at a time. Refer to "OPERATING INSTRUCTIONS", pages 12-14.



**This document sets out the terms and conditions of the product warranties for Westinghouse Appliances. It is an important document. Please keep it with your proof of purchase documents in a safe place for future reference should there be a manufacturing defect in your Appliance. This warranty is in addition to other rights you may have under the Australian Consumer Law.**

**1. In this warranty:**

- (a) 'ACL' or 'Australian Consumer Law' means Schedule 2 to the Competition and Consumer Act 2010;
- (b) 'Appliance' means any Electrolux product purchased by you and accompanied by this document;
- (c) 'ASC' means Electrolux's authorised serviced centres;
- (d) 'Westinghouse' is the brand controlled by Electrolux Home Products Pty Ltd of 163 O'Riordan Street, Mascot NSW 2020, ABN 51 004 762 341 in respect of Appliances purchased in Australia and Electrolux (NZ) Limited (collectively "Electrolux") of 3-5 Niall Burgess Road, Mount Wellington, in respect of Appliances purchased in New Zealand;
- (e) 'Warranty Period' means the period specified in clause 3 of this warranty;
- (f) 'you' means the purchaser of the Appliance not having purchased the Appliance for re-sale, and 'your' has a corresponding meaning.

**2. Application:** This warranty only applies to new Appliances, purchased and used in Australia or New Zealand and is in addition to (and does not exclude, restrict, or modify in any way) other rights and remedies under a law to which the Appliances or services relate, including any non-excludable statutory guarantees in Australia and New Zealand.

**3. Warranty Period:** Subject to these terms and conditions, this warranty continues in Australia for a period of 24 months and in New Zealand for a period of 24 months, following the date of original purchase of the Appliance.

**4. Repair or replace warranty:** During the Warranty Period, Electrolux or its ASC will, at no extra charge if your Appliance is readily accessible for service, without special equipment and subject to these terms and conditions, repair or replace any parts which it considers to be defective. Electrolux may, in its absolute discretion, choose whether the remedy offered for a valid warranty claim is repair or replacement. Electrolux or its ASC may use refurbished parts to repair your Appliance. You agree that any replaced Appliances or parts become the property of Electrolux.

**5. Travel and transportation costs:** Subject to clause 7, Electrolux will bear the reasonable cost of transportation, travel and delivery of the Appliance to and from Electrolux or its ASC. Travel and transportation will be arranged by Electrolux as part of any valid warranty claim.

**6. Proof of purchase** is required before you can make a claim under this warranty.

**7. Exclusions:** You may not make a claim under this warranty unless the defect claimed is due to faulty or defective parts or workmanship. This warranty does not cover:

- (a) light globes, batteries, filters or similar perishable parts;
- (b) parts and Appliances not supplied by Electrolux;
- (c) cosmetic damage which does not affect the operation of the Appliance;

- (d) damage to the Appliance caused by:
  - (i) negligence or accident;
  - (ii) misuse or abuse, including failure to properly maintain or service;
  - (iii) improper, negligent or faulty servicing or repair works done by anyone other than an Electrolux authorised repairer or ASC;
  - (iv) normal wear and tear;
  - (v) power surges, electrical storm damage or incorrect power supply;
  - (vi) incomplete or improper installation;
  - (vii) incorrect, improper or inappropriate operation;
  - (viii) insect or vermin infestation;
  - (ix) failure to comply with any additional instructions supplied with the Appliance;

In addition, Electrolux is not liable under this warranty if:

- (a) the Appliance has been, or Electrolux reasonably believes that the Appliance has been, used for purposes other than those for which the Appliance was intended, including where the Appliance has been used for any non-domestic purpose;
- (b) the Appliance is modified without authority from Electrolux in writing;
- (c) the Appliance's serial number or warranty seal has been removed or defaced

**8. How to claim under this warranty:** To enquire about claiming under this warranty, please follow these steps:

- (a) carefully check the operating instructions, user manual and the terms of this warranty;
- (b) have the model and serial number of the Appliance available;
- (c) have the proof of purchase (e.g. an invoice) available;
- (d) telephone the numbers shown below.

**9. Australia:** For Appliances and services provided by Electrolux in Australia: Electrolux goods come with guarantees that cannot be excluded under the Australian Consumer Law. You are entitled to a replacement or refund for a major failure and for compensation for any other reasonably foreseeable loss or damage. You are also entitled to have the Appliance repaired or replaced if the Appliance fails to be of acceptable quality and the failure does not amount to a major failure. 'Acceptable quality' and 'major failure' have the same meaning as referred to in the ACL.

**10. New Zealand:** For Appliances and services provided by Electrolux in New Zealand, the Appliances come with a guarantee by Electrolux pursuant to the provisions of the Consumer Guarantees Act, the Sale of Goods Act and the Fair Trading Act. Where the Appliance was purchased in New Zealand for commercial purposes the Consumer Guarantee Act does not apply.

**11. Confidentiality:** You accept that if you make a warranty claim, Electrolux and its agents including ASC may exchange information in relation to you to enable Electrolux to meet its obligations under this warranty.

**Important Notice**

Before calling for service, please ensure that the steps listed in clause 8 above have been followed.

<b>AUSTRALIA</b>	<b>FOR SERVICE</b> or to find the address of your nearest authorised service centre in Australia <b>PLEASE CALL 13 13 49</b> <small>For the cost of a local call</small>	<b>FOR SPARE PARTS</b> or to find the address of your nearest spare parts centre in Australia <b>PLEASE CALL 13 13 50</b> <small>For the cost of a local call</small>
<b>NEW ZEALAND</b>	<b>FOR SERVICE</b> or to find the address of your nearest authorised service centre in New Zealand <b>PLEASE CALL 0800 10 66 10</b>	<b>FOR SPARE PARTS</b> or to find the address of your nearest spare parts centre in New Zealand <b>PLEASE CALL 0800 10 66 20</b>

**For more information on all Westinghouse appliances, or for dimension and installation information, call into your retailer, phone or email our customer care team or visit our website:**

**AUSTRALIA**

phone: 13 13 49

email: [customercare@electrolux.com.au](mailto:customercare@electrolux.com.au)

web: [westinghouse.com.au](http://westinghouse.com.au)

**NEW ZEALAND**

phone: 0800 10 66 20

email: [customercare@electrolux.co.nz](mailto:customercare@electrolux.co.nz)

web: [westinghouse.co.nz](http://westinghouse.co.nz)

 and WESTINGHOUSE are trademarks of Westinghouse Electric Corporation. Used under license. All Rights Reserved.

Part Number: A19136414-A  
© 2024 Electrolux Home Products Pty Ltd  
ABN 51 004 762 341  
WMAN\_Induction\_June2024